



**AMERICAN HIGH VOLTAGE**  
POWER SUPPLIES FOR THE WORLD

# HTC Series

**HTC Series**

## 200° C High Voltage Power Supply

### General Description

The HTC Series high voltage power supplies are designed to operate at extreme temperatures and in harsh environments especially for the oil well logging industry. The HTC units provide up to 3kV at 100uA of regulated output, with either positive or negative polarity. All models are adjustable over a 3:1 output voltage range by either voltage or resistance programming. Temperature drift is less than 100 ppm/deg C by using advanced internal reference and drift compensation techniques. All models are reverse input and output arc and short circuit protected.

### Features

- Regulated
- Encapsulated and Shielded
- Voltage and Resistance programmable
- 1kV, 2kV and 3kV available
- Various input voltages available
- Positive or Negative Polarity
- **Low Temperature Drift (+/-10VDC) Option available**

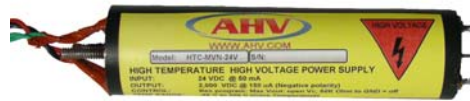

### Connection Diagram/ Outline Drawing

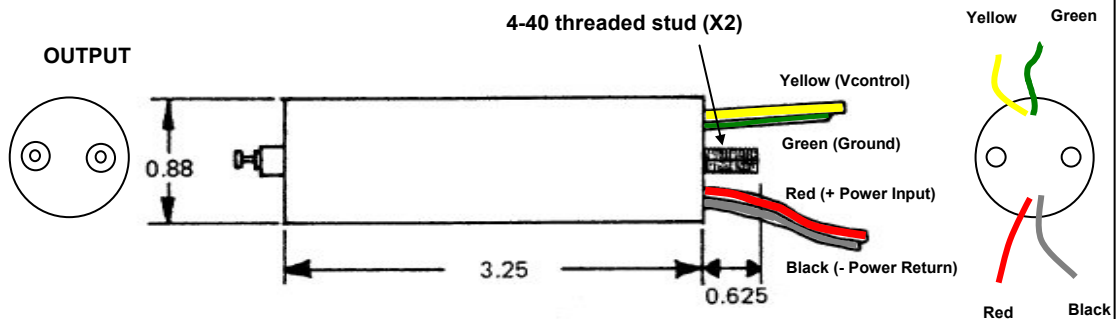

Cylindrical Configuration (HTC)



**AMERICAN HIGH VOLTAGE**  
POWER SUPPLIES FOR THE WORLD

## Electrical Characteristics

(at 25 degrees C unless otherwise specified)

**HTC Series**

Parameter	Conditions	Value			Units
		Min	Typical	Max	
Supply Voltage*:	HTC - 15	14 VDC	15VDC	16 VDC	VDC
	HTC - 24	22 VDC	24VDC	26 VDC	VDC
	HTC - 30	27 VDC	30VDC	33 VDC	VDC
Input Current:	No Load (-15 model):	45	50	55	mA
	No Load (-24 model):	30	35	40	mA
	No Load (-30 model):	30	35	40	mA
	Full Load (-15 model):	75	80	85	mA
	Full Load (-24 model):	36	40	44	mA
	Full Load (-30 model):	36	40	44	mA
Output Ripple:	No Load (all models):	0.015 %	0.02 %	0.03 %	Vpp
	Full Load @ 200°C(all models):	0.02 %	0.03 %	0.05%	Vpp
Load Regulation:	No Load to Full Load	0.1 %	0.2 %	0.25 %	$V_{NL}/V_L$
	Half Load to Full Load	0.1 %	0.1 %	0.2 %	$V_{NL}/V_L$
Output Linearity	No Load		1%		$\Delta V_{OUT}$ ----- $\Delta V_{OUT}$ (ideal)
Output Linearity	Full Load (all models):		1%		$\Delta V_{OUT}$ ----- $\Delta V_{OUT}$ (ideal)
Short Circuit Current:	(maximum input current)		100	125	mA
Power Efficiency:	Full Load	20%	25%	30%	$P_{OUT}$ ----- $P_{IN}$
Reverse Input Polarity	Protected to 50 VDC				
Temperature Drift: (Low Temp Drift Option Available)	No Load		50	100	ppm/DegC
	Full Load		50	100	ppm/Deg C
Thermal Rise:	No Load (case)			2	degrees C
	Full Load (case)			5	degrees C
Slew Rate (10% - 90%)	No Load			100	mS
	Full Load			120	mS
Slew Rate (90% - 10%)	No Load			200	mS
	Full Load			100	mS
Drain Out Time	No Load (5 TC)			150	mS



**AMERICAN HIGH VOLTAGE**  
POWER SUPPLIES FOR THE WORLD

**HTC Series**

## Physical Characteristics

(at 25 degrees C unless otherwise specified)

### Cylindrical Shape (HTC)

Parameter	Conditions	Value	Units
Dimensions	MKS	82.55 L x 22.35 diameter	mm
	English	3.25 L x 0.88 diameter	inches
Volume:	MKS	32.39	cm <sup>3</sup>
	English	1.98	inch <sup>3</sup>
Weight:	MKS	100	grams
	English	3.53	oz
Packaging:	Brass Tubing with solid epoxy encapsulation		
Terminations:	Input:	Flying Teflon leads #22 AWG	
	Output:	Teflon Terminals	

## Environmental Characteristics

(at 25 degrees C unless otherwise specified)

Parameter	Conditions	Value	Units
Temperature Range	case temperature	-40 degrees to + 200 degrees	Celsius
	case temperature	-40 degrees to + 392 degrees	Fahrenheit
Shock:	½ Sine, 5 msec Duration	225 g's	
Vibrations:	250 Hz Random	25 g's	Curve E
Pressure		0 to 500PSIG	



**AMERICAN HIGH VOLTAGE**  
POWER SUPPLIES FOR THE WORLD

## HTC Series Performance Charts

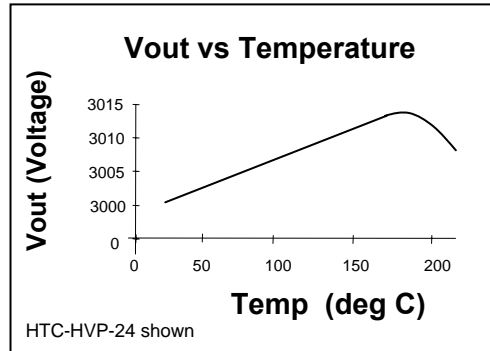
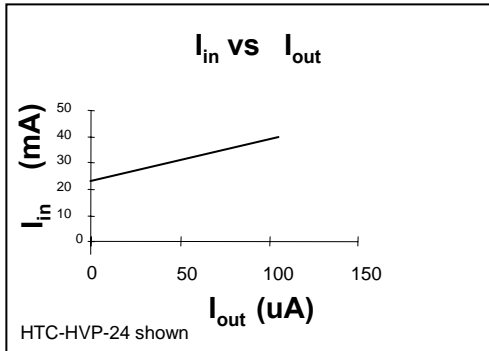

## HTC Series Application Notes

HTC Series high voltage power supplies are regulated against both line and load changes. Input current as a function of load is shown above, as is output voltage as a function temperature. Setting the output voltage to a fixed value which is lower than the unit's maximum output can be accomplished by either of two methods. In the resistance programming mode, a resistor is inserted between the Control Pin (Yellow control wire) and the Ground Pin (Green ground wire). For positive output units, a resistance value of zero Ohms yields the maximum output voltage. Figure 1 shows the connections for a positive output power supply. Figure 2 shows the output voltage as a function of control resistor.

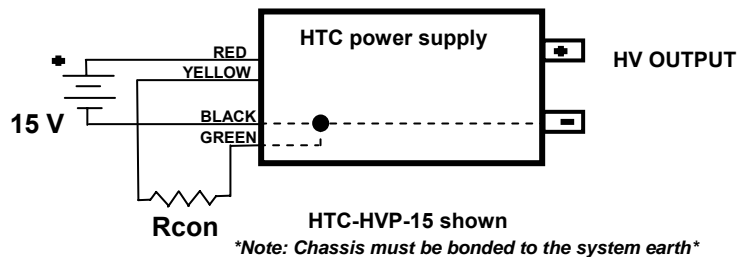

Figure 1: Resistance program of positive output of HTC



**AMERICAN HIGH VOLTAGE**  
POWER SUPPLIES FOR THE WORLD

## HTC Series Application Notes (continued)

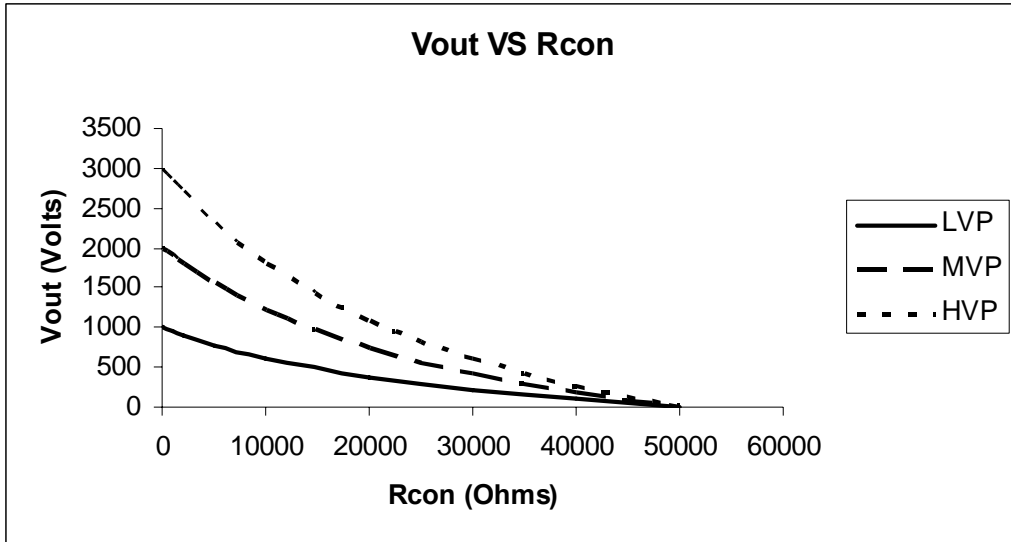

Figure 2: Positive Style HTC Output Voltage as a function of control resistor

Some models of the HTC Series high voltage power supplies can provide a negative output voltage. To set the output voltage to a fixed value lower than the maximum that the unit can provide is easily accomplished. In the resistance programming mode, a resistor is inserted between the Control Pin (Yellow control wire) and the Ground Pin (Green ground wire). For negative output units, an open circuit yields the maximum output voltage. Figure 3 shows the connections for a negative output power supply. Figure 4 shows the output voltage as a function of control resistor.

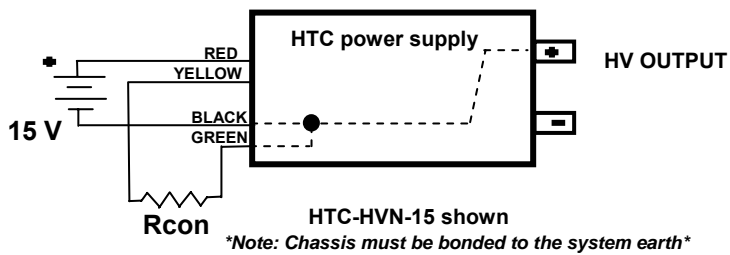

Figure 3: Resistance program of negative output of HTC



**AMERICAN HIGH VOLTAGE**  
POWER SUPPLIES FOR THE WORLD

## HTC Series Application Notes (continued)

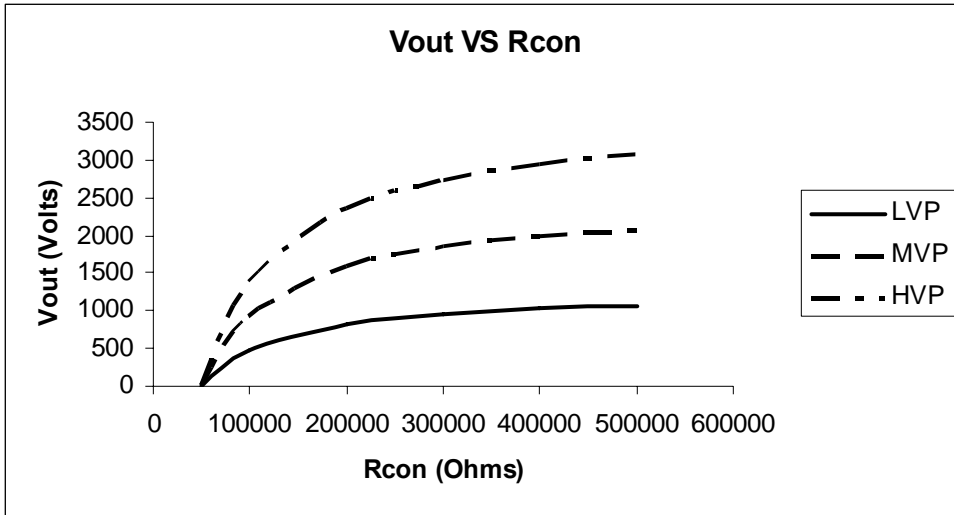

Figure 4: Negative Style HTC Output Voltage as a function of control resistor

All HTC power supplies can be controlled by an external reference voltage placed into the Control Pin (YELLOW lead wire). Figure 5 details this connection for positive style output units while Figure 6 shows the effect of this external voltage on the output voltage of the unit. The power supply will regulate at the set voltage and be stable against line and load variations as long as the external control voltage is fixed in magnitude.

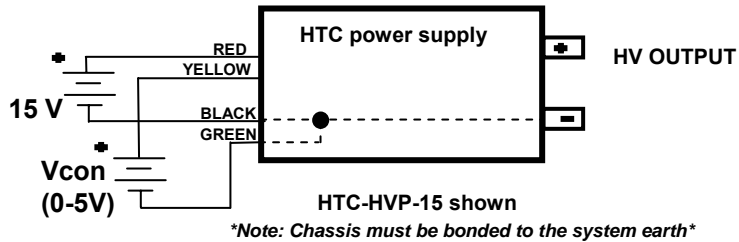

Figure 5: Voltage program of positive output of HTC



AMERICAN HIGH VOLTAGE  
POWER SUPPLIES FOR THE WORLD

## HTC Series Application Notes (continued)

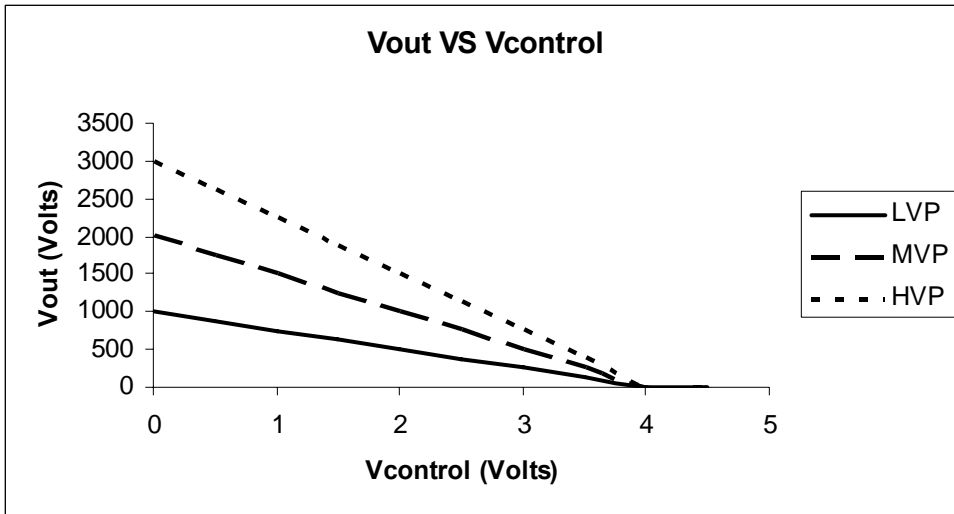

Figure 6: Positive Style HTC Output Voltage as a function of program voltage  
*Different Voltage programming mode is available*

Negative output HTC power supplies can also be controlled by an external reference voltage placed into the Control Pin (YELLOW lead wire). Figure 7 details this connection for negative style output units while Figure 8 shows the effect of this external voltage on the output voltage of the unit. The power supply will regulate at the set voltage and be stable against line and load variations as long as the external control voltage is fixed in magnitude.

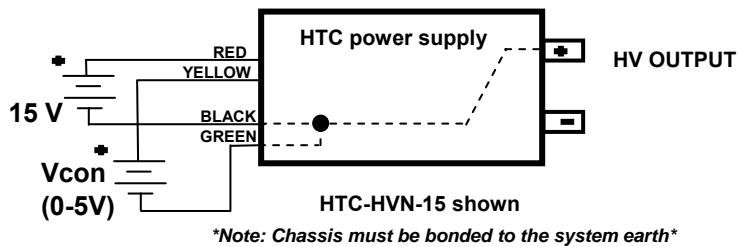

Figure 7: Voltage program of negative output of HTC



**AMERICAN HIGH VOLTAGE**  
POWER SUPPLIES FOR THE WORLD

## HTC Series Application Notes (continued)

**HTC Series**

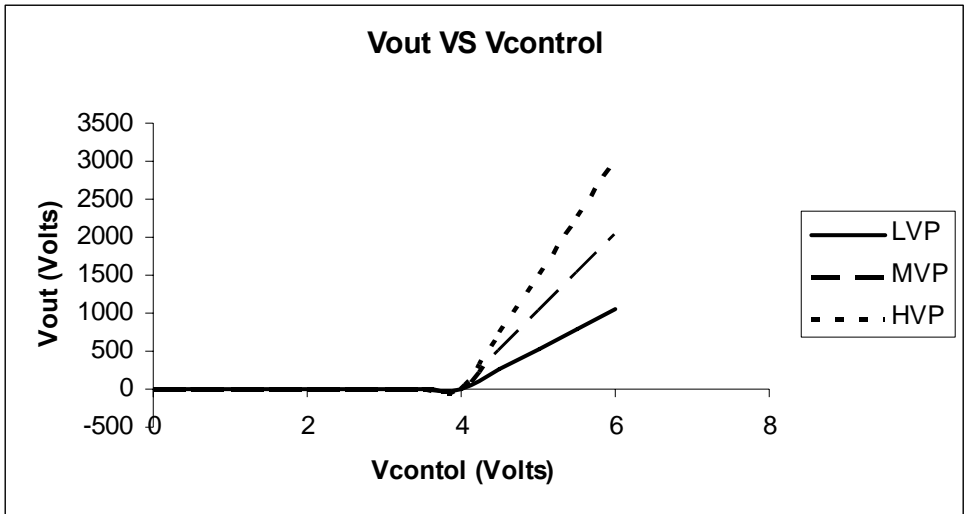
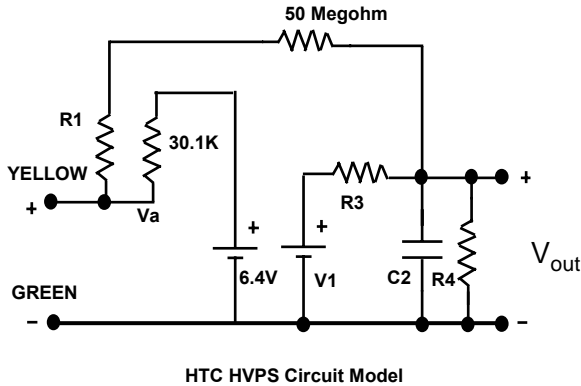

Figure 8: Negative Style HTC Output Voltage as a function of program voltage  
*Different Voltage programming mode is available*

## Equivalent HTC Circuit Model



R1 = 201K Ohm (LVP), 100K Ohm (MVP), 67K Ohm (HVP)  
90K Ohm (LVN), 30K Ohm (MVN), 10K Ohm (HVN)

R3 = 1 K Ohms  
R4 = 100 Megohms  
C2 = (3 x 10<sup>-9</sup>) Farads

V1 = Positive output units:  $4.01 + (2 E8) / R1 - (50 E6)(Va)/R1$   
= Negative output units:  $(50 E6)(Va)/R1 - (2 E8)/R1 + 4.01$





**AMERICAN HIGH VOLTAGE**  
POWER SUPPLIES FOR THE WORLD

**Ordering Information:**

**Cylindrical Shape:**

**HTC-XVY – Z – LD**

X = Output voltage range: L = 1KV, M = 2KV, MH = 2.5KV, H = 3KV  
Y = polarity P = positive, N = negative  
Z = Input voltage 15, 24, 30  
LD = Low Temperature Drift (+/-10VDC from 25°C to 200°C)

**Example:**

- HTC-LVP-24: Maximum output = 1,000VDC positive polarity, 24VDC input
- HTC-LVP-24 - LD: Maximum output = 1,000VDC positive polarity, 24VDC input, Low Temp Drift
- HTC-MVP-15: Maximum output = 2,000VDC positive polarity, 15VDC input
- HTC-MVP-15 - LD: Maximum output = 2,000VDC positive polarity, 15VDC input, Low Temp Drift
- HTC-MHVP-15: Maximum output = 2,500VDC positive polarity, 15VDC input
- HTC-MHVP-15 - LD: Maximum output = 2,500VDC positive polarity, 15VDC input, Low Temp Drift
- HTC-HVN-30: Maximum output = 3,000VDC negative polarity, 30VDC input
- HTC-HVN-30 - LD: Maximum output = 3,000VDC negative polarity, 30VDC input, Low Temp Drift

*\*Only Solder AHV's High Temperature products with HMP Solder.*

*\*\* Different Voltage Programming mode is available, please contact factory – Phone: 775-777-0992  
Email: [ahv@ahv.com](mailto:ahv@ahv.com)*