



AMERICAN HIGH VOLTAGE
POWER SUPPLIES FOR THE WORLD

H25B Series

H25B Series

200° C High Voltage Power Supply

General Description

The H25B Series high voltage power supplies are designed to operate at extreme temperatures and in harsh environments especially for the oil well logging industry. The H25B units provide up to 3kV at 100uA of regulated output, with either positive or negative polarity. All models are adjustable over a 3:1 output voltage range by either voltage or resistance programming. Temperature drift is less than 100 ppm/deg C by using advanced internal reference and drift compensation techniques. All models are reverse input and output arc and short circuit protected.

Features

- Regulated
- Encapsulated and Shielded
- Voltage and Resistance programmable
- 1kV, 2kV and 3kV available
- Various input voltages available
- Positive or Negative Polarity



Connection Diagram/ Outline Drawing

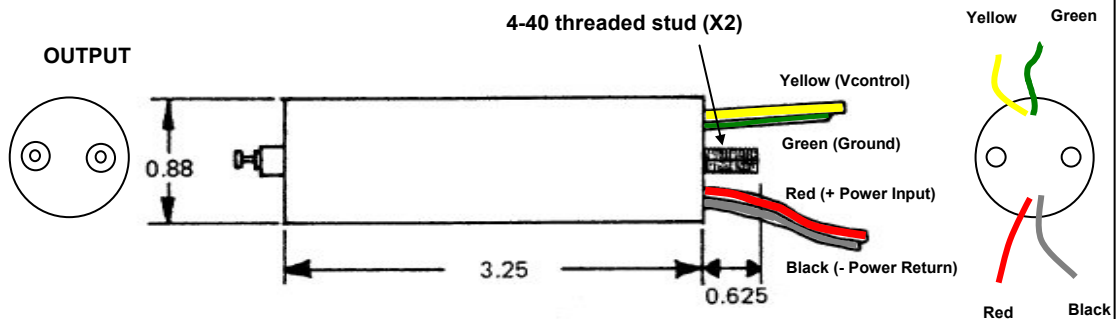

Cylindrical Configuration (H25B)



AMERICAN HIGH VOLTAGE
POWER SUPPLIES FOR THE WORLD

H25B Series

Electrical Characteristics

(at 25 degrees C unless otherwise specified)

Parameter	Conditions	Value			Units
		Min	Typical	Max	
Supply Voltage*:	H25B - 15	14 VDC	15VDC	16 VDC	VDC
	H25B - 24	22 VDC	24VDC	26 VDC	VDC
	H25B - 30	27 VDC	30VDC	33 VDC	VDC
Input Current:	No Load (-15 model):	45	50	55	mA
	No Load (-24 model):	30	35	40	mA
	No Load (-30 model):	30	35	40	mA
	Full Load (-15 model):	75	80	85	mA
	Full Load (-24 model):	36	40	44	mA
	Full Load (-30 model):	36	40	44	mA
Output Ripple:	No Load (all models):	0.015 %	0.02 %	0.03 %	Vpp
	Full Load (@ 200°C all models):	0.02 %	0.03 %	0.05%	Vpp
Load Regulation:	No Load to Full Load	0.1 %	0.2 %	0.25 %	V_{NL}/V_L
	Half Load to Full Load	0.1 %	0.1 %	0.2 %	V_{NL}/V_L
Output Linearity	No Load		1%		$\frac{\Delta V_{OUT}}{\Delta V_{OUT} (ideal)}$
Output Linearity	Full Load (all models):		1%		$\frac{\Delta V_{OUT}}{\Delta V_{OUT} (ideal)}$
Short Circuit Current:	(maximum input current)		100	125	mA
Power Efficiency:	Full Load	20%	25%	30%	$\frac{P_{OUT}}{P_{IN}}$
Reverse Input Polarity	Protected to 50 VDC				
Temperature Drift:	No Load		50	100	ppm/DegC
	Full Load		50	100	ppm/Deg C
Thermal Rise:	No Load (case)			2	degrees C
	Full Load (case)			5	degrees C
Slew Rate (10% - 90%)	No Load			100	mS
	Full Load			120	mS
Slew Rate (90% - 10%)	No Load			200	mS
	Full Load			100	mS
Drain Out Time	No Load (5 TC)			150	mS



AMERICAN HIGH VOLTAGE
POWER SUPPLIES FOR THE WORLD

H25B Series

Physical Characteristics

(at 25 degrees C unless otherwise specified)

Cylindrical Shape (H25B)

Parameter	Conditions	Value	Units
Dimensions	MKS	82.55 L x 22.35 diameter	mm
	English	3.25 L x 0.88 diameter	inches
Volume:	MKS	32.39	cm ³
	English	1.98	inch ³
Weight:	MKS	100	grams
	English	3.53	oz
Packaging:	Brass Tubing with solid epoxy encapsulation		
Terminations:	Input:	Flying Teflon leads #22 AWG	
	Output:	Teflon Terminals	

Environmental Characteristics

(at 25 degrees C unless otherwise specified)

Parameter	Conditions	Value	Units
Temperature Range	case temperature	-40 degrees to + 200 degrees	Celsius
	case temperature	-40 degrees to + 392 degrees	Fahrenheit
Shock:	½ Sine, 5 msec Duration	225 g's	
Vibrations:	250 Hz Random	25 g's	Curve E
Pressure		0 to 500PSIG	



AMERICAN HIGH VOLTAGE
POWER SUPPLIES FOR THE WORLD

H25B Series Performance Charts

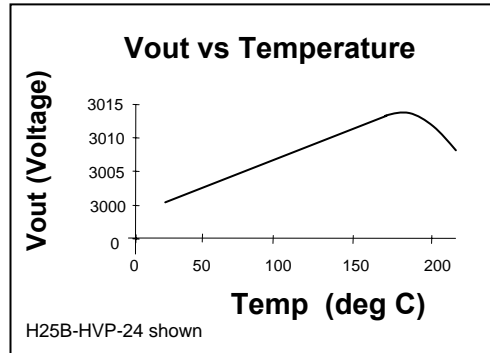
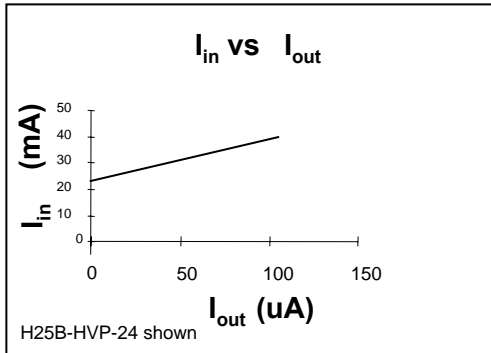

H25B Series Application Notes

H25B Series high voltage power supplies are regulated against both line and load changes. Input current as a function of load is shown above, as is output voltage as a function temperature. Setting the output voltage to a fixed value which is lower than the unit's maximum output can be accomplished by either of two methods. In the resistance programming mode, a resistor is inserted between the Control Pin (Yellow control wire) and the Ground Pin (Green ground wire). For positive output units, a resistance value of zero Ohms yields the maximum output voltage. Figure 1 shows the connections for a positive output power supply. Figure 2 shows the output voltage as a function of control resistor.

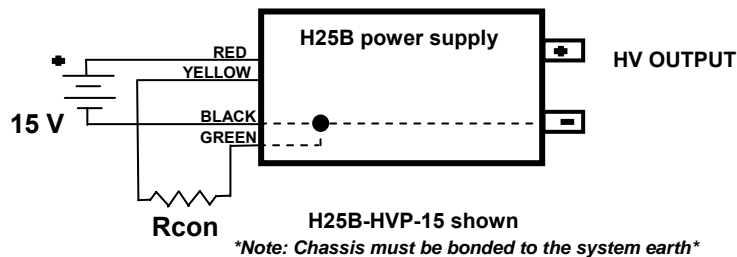

Figure 1: Resistance program of positive output of H25B



AMERICAN HIGH VOLTAGE
POWER SUPPLIES FOR THE WORLD

H25B Series Application Notes (continued)

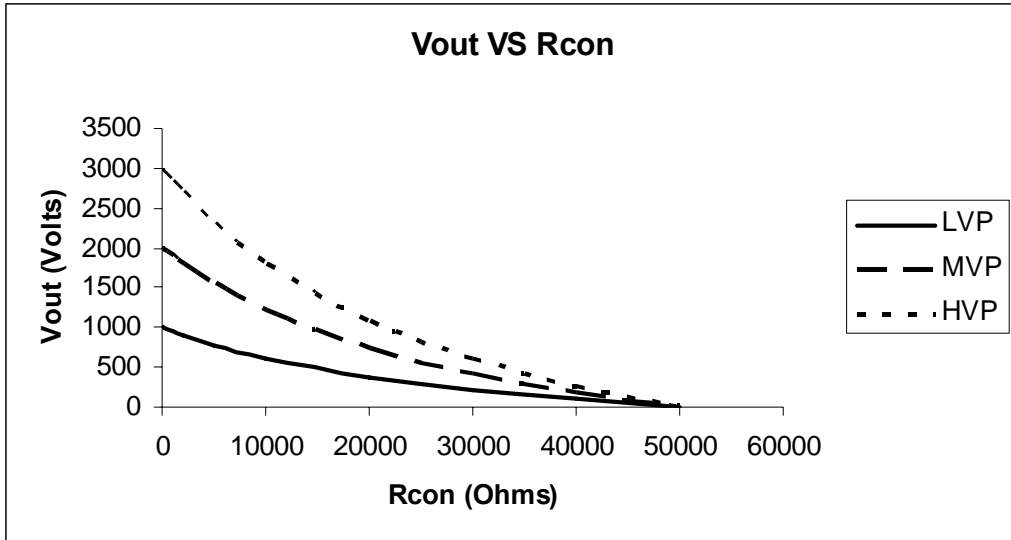

Figure 2: Positive Style H25B Output Voltage as a function of control resistor

Some models of the H25B Series high voltage power supplies can provide a negative output voltage. To set the output voltage to a fixed value lower than the maximum that the unit can provide is easily accomplished. In the resistance programming mode, a resistor is inserted between the Control Pin (Yellow control wire) and the Ground Pin (Green ground wire). For negative output units, an open circuit yields the maximum output voltage. Figure 3 shows the connections for a negative output power supply. Figure 4 shows the output voltage as a function of control resistor.

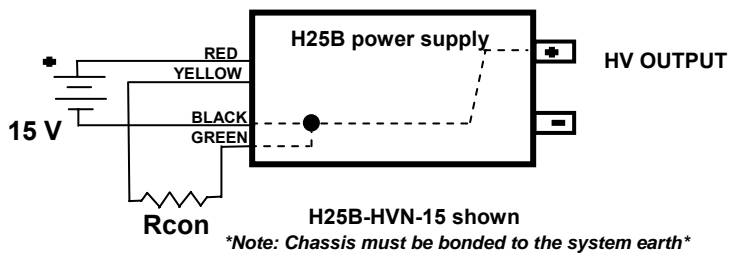

Figure 3: Resistance program of negative output of H25B



AMERICAN HIGH VOLTAGE
POWER SUPPLIES FOR THE WORLD

H25B Series Application Notes (continued)

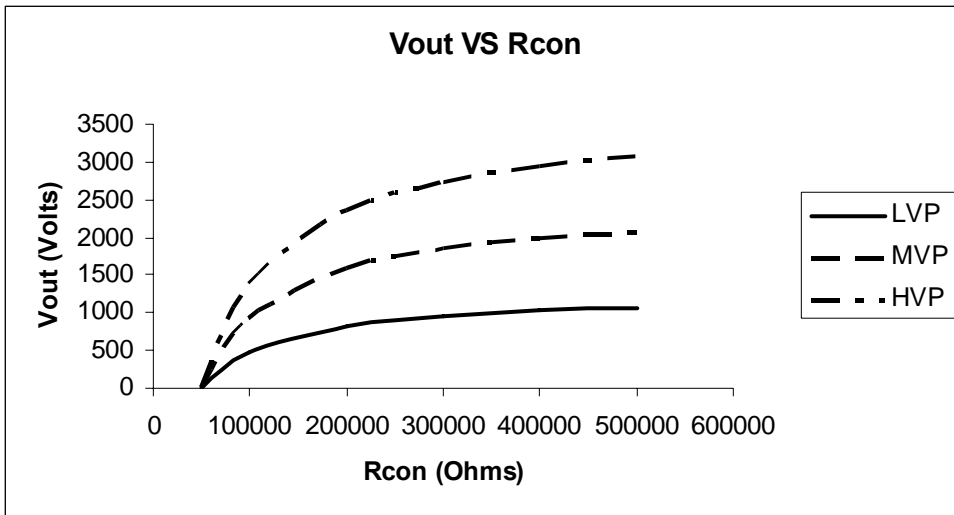

Figure 4: Negative Style H25B Output Voltage as a function of control resistor

All H25B power supplies can be controlled by an external reference voltage placed into the Control Pin (YELLOW lead wire). Figure 5 details this connection for positive style output units while Figure 6 shows the effect of this external voltage on the output voltage of the unit. The power supply will regulate at the set voltage and be stable against line and load variations as long as the external control voltage is fixed in magnitude.

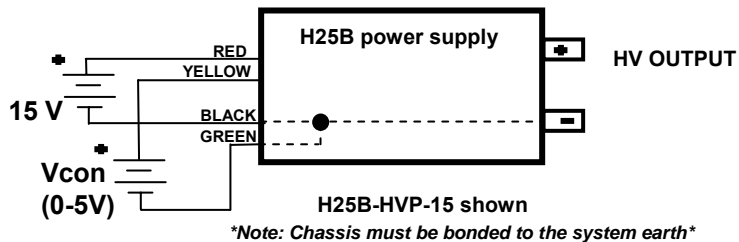

Figure 5: Voltage program of positive output of H25B



AMERICAN HIGH VOLTAGE
POWER SUPPLIES FOR THE WORLD

H25B Series Application Notes (continued)

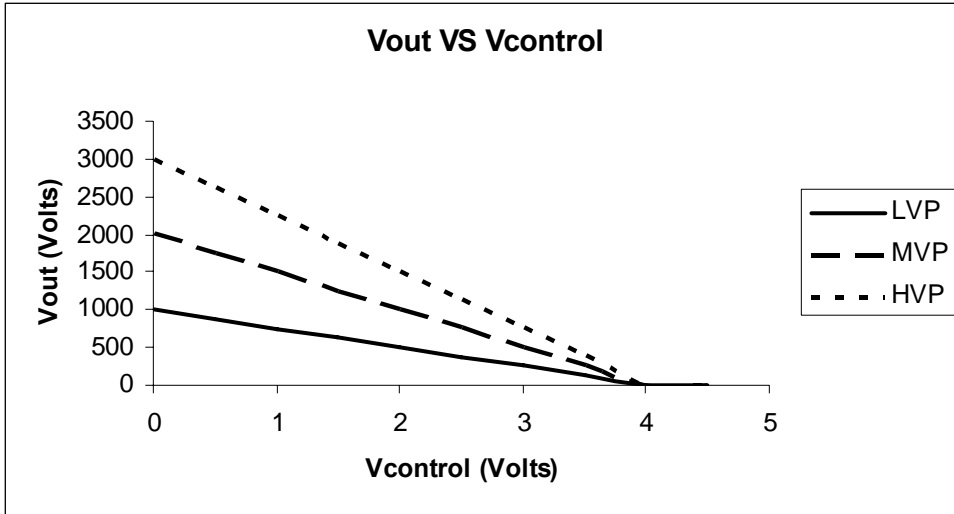

Figure 6: Positive Style H25B Output Voltage as a function of program voltage

Negative output H25B power supplies can also be controlled by an external reference voltage placed into the Control Pin (YELLOW lead wire). Figure 7 details this connection for negative style output units while Figure 8 shows the effect of this external voltage on the output voltage of the unit. The power supply will regulate at the set voltage and be stable against line and load variations as long as the external control voltage is fixed in magnitude.

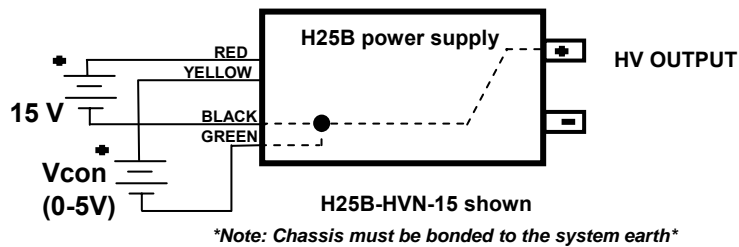

Figure 7: Voltage program of negative output of H25B



AMERICAN HIGH VOLTAGE
POWER SUPPLIES FOR THE WORLD

H25B Series Application Notes (continued)

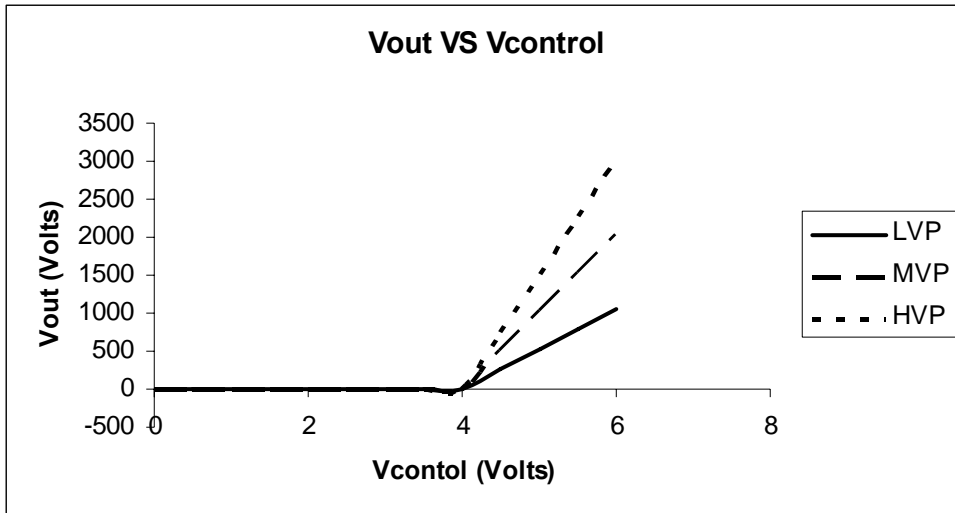
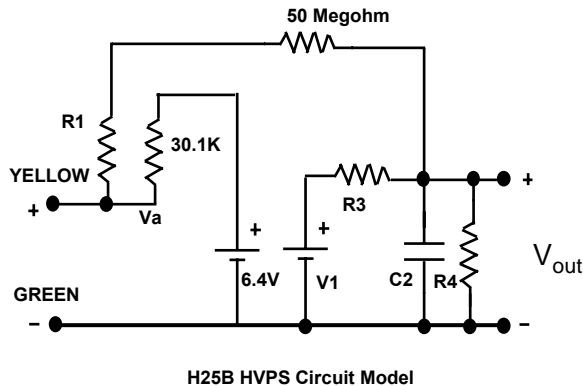

Figure 8: Negative Style H25B Output Voltage as a function of program voltage

Equivalent H25B Circuit Model



- R1 = 201K Ohm (LVP), 100K Ohm (MVP), 67K Ohm (HVP)
90K Ohm (LVN), 30K Ohm (MVN), 10K Ohm (HVN)
- R3 = 1 K Ohms
- R4 = 100 Megohms
- C2 = (3 x 10⁻⁹) Farads

V1 = Positive output units: $4.01 + (2 E8) / R1 - (50 E6)(Va)/R1$
 = Negative output units: $(50 E6)(Va)/R1 - (2 E8)/R1 + 4.01$



AMERICAN HIGH VOLTAGE
POWER SUPPLIES FOR THE WORLD

Ordering Information:

Cylindrical Shape:

H25B-XVY - Z

X = Output voltage range: L = 1KV, M = 2KV, MH = 2.5KV, H = 3KV
Y = polarity P = positive, N = negative
Z = Input voltage 15, 24, 30

Example:

H25B-LVP-24:	Maximum output = 1,000VDC positive polarity, 24VDC input
H25B-MVP-15:	Maximum output = 2,000VDC positive polarity, 15VDC input
H25B-MHVP-15:	Maximum output = 2,500VDC positive polarity, 15VDC input
H25B-HVN-30:	Maximum output = 3,000VDC negative polarity, 30VDC input

**Only Solder AHV's High Temperature products with HMP Solder.*